

## VT670-FHD-IPC









# VT670-FHD-IPC

## NUMBER PLATE CAMERA

Water-resistant with an IP69K rating, the **VT670-FHD-IPC** works as a rear-view camera. It has a super-wide viewing angle, is durable in all weather conditions and mounts perfectly on all number plates.

### Key features:

 Full HD	 Wide-viewing Angle	 Colour Illumination
 AWB	 IR Night Vision	 IP Rating

- ✓ Resolution: FHD 1080P
- ✓ 150° FOV
- ✓ Minimum illumination: 0.1Lux (Colour illumination)
- ✓ 0Lux (IR on)
- ✓ Automatic electronic shutter, AWB
- ✓ IR distance: 3-5m
- ✓ IP69K



**t** +44 (0) 1246 225 745  
**e** info@visiontrack.com  
**w** visiontrack.com  
**s** support.visiontrack.com

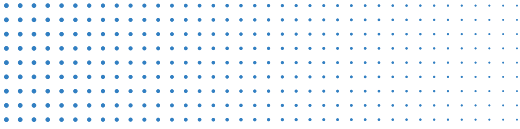

## VT670-FHD-IPC

### Specifications:

<b>Sensor</b>	1/2.9" 2.0M Pixel CMOS
<b>Resolution</b>	FHD 1080P
<b>Minimum illumination</b>	0.1Lux (Colour Illumination), 0Lux (IR on)
<b>Electronic shutter</b>	1/30s-1/10000s
<b>ICR</b>	ICR Infrared filter
<b>Adjustable angle</b>	Horizontal up 30°, Horizontal down 45°
<b>BLC</b>	Supports
<b>S/N</b>	≥48db
<b>DNR</b>	3D DNR
<b>IR</b>	3-5m
<b>Lens</b>	150°
<b>Video compression standard</b>	H.264
<b>Compression output rate</b>	32Kbps-6Mbps
<b>Resolution</b>	Main Stream: 1080P@15fps / 720P@25fps Sub Stream: VGA/DI/CIF@15FPS Network Stream: CIF@10FPS (Adaptive)
<b>Network interface</b>	10M/100M adaptive Ethernet port (6PIN aviation) Compatible with T3000/VT5500-G/VT6.2 and VT8000 models
<b>Operation temperature</b>	-40°C +70°C
<b>Operation humidity</b>	0% - 95%
<b>Power supply</b>	PON (DC12V ±10%) Powered from VT3000/VT5500-G/VT6.2 and VT8000 (PON Required) models
<b>Consumption (Max.)</b>	VT5500-G/VT6.2/VT3000/VT8000
<b>IP Rate</b>	IP69K
<b>Dimension</b>	196.7mmx29.5mmx30mm (LxWxH)
<b>Net Weight</b>	200g

### Dimensions:

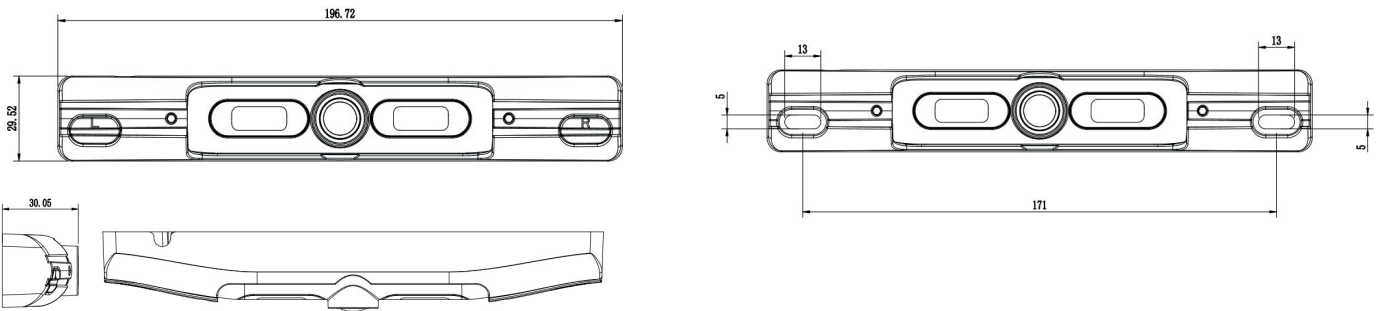

### Video output:

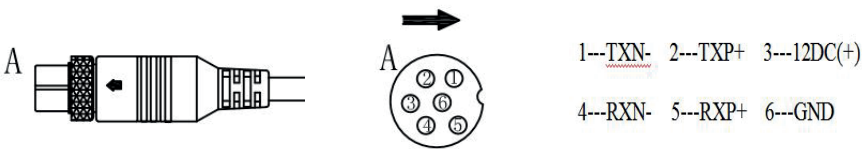

**t** +44 (0) 1246 225 745  
**e** info@visiontrack.com  
**w** visiontrack.com  
**s** support.visiontrack.com